

Roofer

F12A09A32

Benjamin Hubert



Fixture Type

Project Name



Dimensions

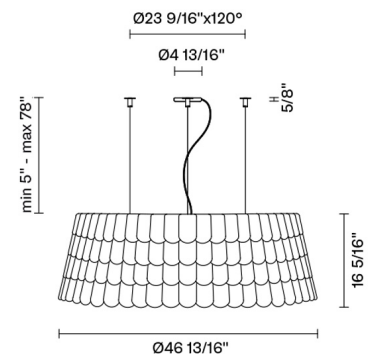

Description

Pendant lamp with three tone coloured scales, made of semi-rigid rubbery material.

Voltage

120V

Socket

12xE26

Specs



DRY

Material

Polypropylene - Metal

Light source

12 X 32W Max E26 120V incandescent or retrofit LED

Color

■ Orange

Other colors available

Check online www.fabbian.us

Notes

Derating label available upon request

Not included accessories

Bulb

In the same family











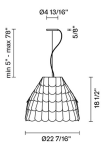

Pendant

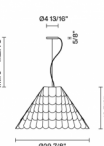

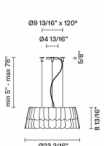
Pendant

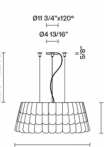
Roofer F12

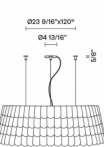
Other options

	code	electrification	technical info
 	F12 A01 A 01 F12 A01 A 21 F12 A01 A 32 F12 A01 A 43	E26 120V 250W	 DRY
 	F12 A03 A 01 F12 A03 A 21 F12 A03 A 32 F12 A03 A 43	E26 120V 250W	 DRY
 	F12 A05 A 01 F12 A05 A 21 F12 A05 A 32 F12 A05 A 43	6x E26 120V 23W	 DRY
 	F12 A07 A 01 F12 A07 A 21 F12 A07 A 32 F12 A07 A 43	6x E26 120V 32W	 DRY
 	F12 A09 A 01 F12 A09 A 21 F12 A09 A 32 F12 A09 A 43	12x E26 120V 32W	 DRY