

Etnia F68

F68A11A03

Minelli Fossati design studio



Fixture type

Project name

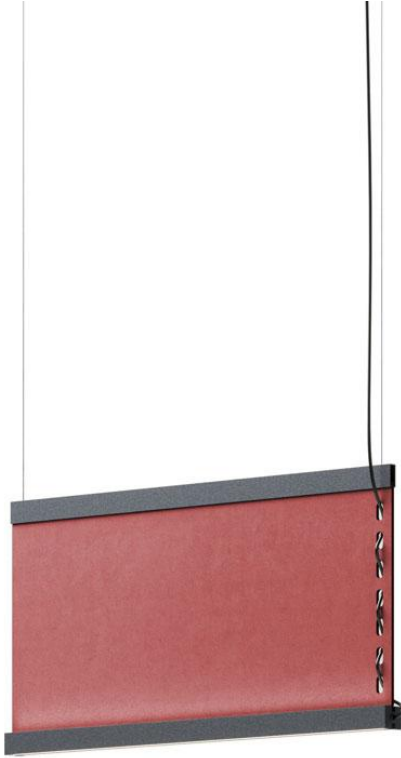

Dimensions

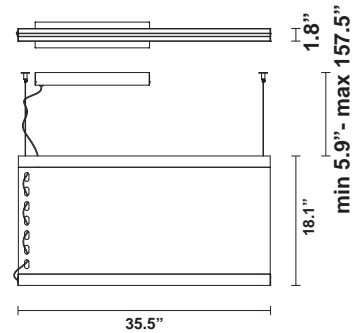

Material

Recycled PET, Fabric, Aluminium, PMMA

Color



Strawberry Red

Other colors available

Check online www.fabbian.us

Included accessories

LED, Dimmable electronic driver

Weight Lamp

9.95 lbs

Description

Linear pendant for direct and indirect illumination with Recycled PET fabric panels with sound-absorbing properties. Black anodized aluminum structure with PMMA diffusers.

Dimmable

0-10V

Light source and Technical

Lamp type: LED

Wattage: 40W Up / 40W Down

Color temperature: 3000K

CRI: 90+

Lumens: 3690 Up / 4480 Down