

Etnia F68

**F68A61A16**

Minelli Fossati design studio

Fixture type

Project name



## Dimensions

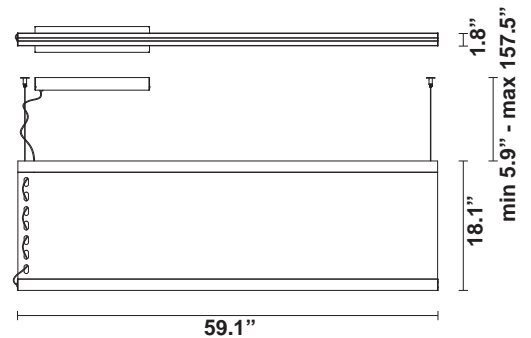

## Material

Recycled PET, Fabric, Aluminium, PMMA

## Color

 Sand

## Other colors available

Check online [www.fabbian.us](http://www.fabbian.us)

## Included accessories

LED, Dimmable electronic driver

## Weight Lamp

13.3 lbs

## Description

Linear pendant for direct and indirect illumination with Recycled PET fabric panels with sound-absorbing properties. Black anodized aluminum structure with PMMA diffusers.

## Dimmable

0-10V

## Light source and Technical

**Lamp type:** LED

**Wattage:** 65W Up / 65W Down

**Color temperature:** 3000K

**CRI:** 90+

**Lumens:** 6150 Up / 7460 Down