

Etnia F68

F68A62A03

Minelli Fossati design studio

Fixture type

Project name



Dimensions

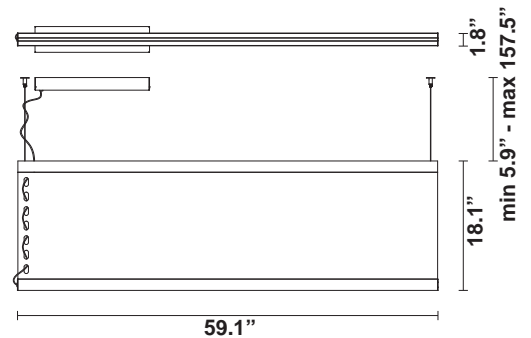

Material

Recycled PET, Fabric, Aluminium, PMMA

Color

 Strawberry Red

Other colors available

Check online www.fabbian.us

Included accessories

LED, Dimmable electronic driver

Weight Lamp

13.3 lbs

Description

Linear pendant for direct and indirect illumination with Recycled PET fabric panels with sound-absorbing properties. Black anodized aluminum structure with PMMA diffusers.

Dimmable

0-10V

Light source and Technical

Lamp type: LED

Wattage: 65W Up / 65W Down

Color temperature: 2700K

CRI: 90+

Lumens: 6150 Up / 7460 Down